



SIDETRAK

USER MANUAL





SIDETRAK[®]

We can't wait to travel with you!
Send pictures of your setup on social media!



sidetrak.com



facebook.com/sidetrakmonitor



[@sidetrakmonitor](https://twitter.com/sidetrakmonitor)



[@sidetrak.monitor](https://www.instagram.com/sidetrak.monitor)

Contact Us

(240) 580-8725

customerservice@sidetrak.com

WELCOME TO A MORE PRODUCTIVE YOU

To get started, go to sidetrak.com/pages/downloads to install free driver and watch installation video!



Watch installation for Windows video here

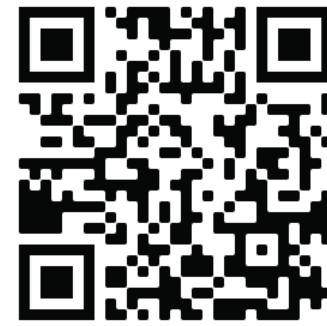

Watch installation for Mac video here

Contents



4	Component List
5–8	Downloads
9–11	Installation
12	Everyday Use & Removal
13	Configuring a Second Screen: PC
14	Configuring a Second Screen: Mac
15	FAQs
16	Troubleshooting
17	Technical Specifications
18	Limited Liability Warranty

Component List

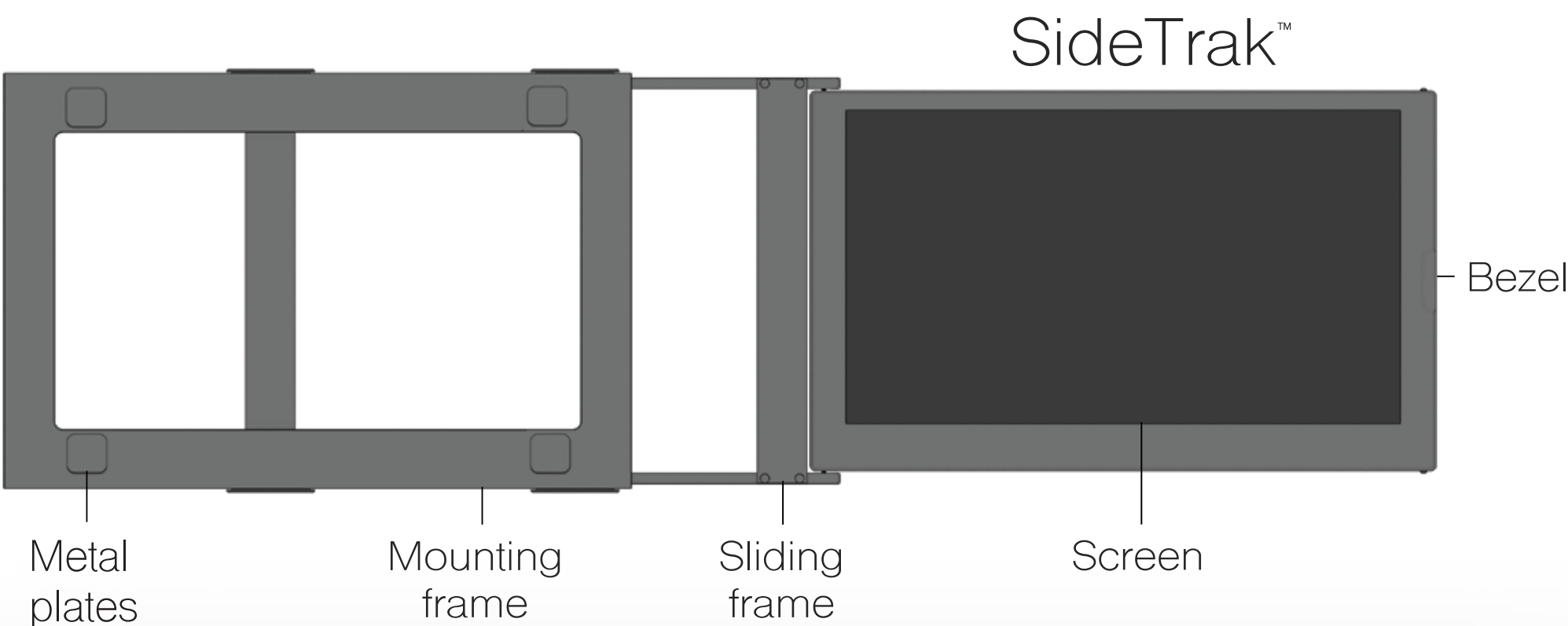

USB-C cord with USB-A adapter



Extra set of (4) metal plates



Removal tool

Download Free DisplayLink Driver

Go to sidetrak.com/pages/downloads to install the free DisplayLink Driver and watch installation video

Select your operating system (Windows, Chromebook, or Mac) to proceed with installation

For Windows:



- 1) Find out what version of Windows your laptop is currently running
Select the Start button, then select Settings > System > About
Under Windows specifications, you can see which edition and version of Windows your device is running.

About	
Windows specifications	
Edition	Windows 10
Version	1803
Installed on	2/15/2019
OS build	17134.885

- 2) Select the corresponding version of DisplayLink Driver
Note: At this time, you may also choose to update your Windows software to the most recent version (if applicable)



For Windows cont.

- 3) Follow prompts to install DisplayLink Driver
 - Double-click on file named "Setup.exe"
 - Read user agreement and select appropriate prompt.



- 4) Wait for DisplayLink to install
 - Note: Once DisplayLink has successfully installed, **restart your laptop**
 - Once your laptop is restarted, plug in SideTrak to check for compatibility.
 - Wait 2 minutes and 30 seconds for SideTrak to connect**



For any questions or troubleshooting, visit sidetrak.com/pages/download-windows to watch video tutorials

For Mac:

Go to sidetrak.com/pages/downloads to install the free DisplayLink Driver and watch installation video



- 1) Find out what version of Mac OSX you are currently running.
Select the Apple icon in the top left of screen, then select About This Mac window subheading will show which version your laptop is currently running



- 2) Select the corresponding version of DisplayLink Driver
Download applicable driver
We recommend Mac users update to most current software (if applicable)

For Mac cont.

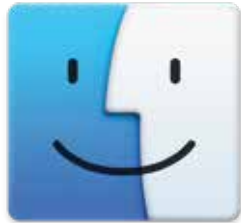

- 3) Follow prompts to install DisplayLink Driver
 Double-click on dmg file, then click on the Installer pkg file
 Follow prompts to install to laptop disk, then read user agreement and select appropriate prompt,



- 4) Allow DisplayLink to finish installing

- 5) Allow DisplayLink

On some Mac computers, you will need to allow access to DisplayLink. If you do, you should be prompted with this message.

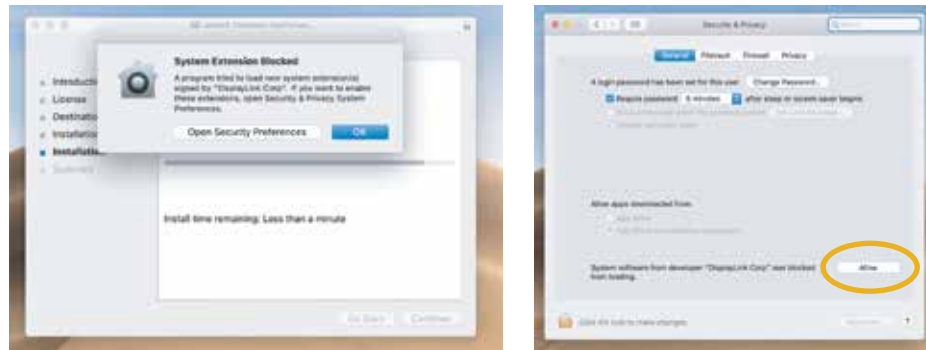

Then click “Open Security Preferences”. Unlock the lock in the bottom corner of your system preferences window. Click “Allow” and click the lock in the bottom corner again to secure.

Note: Once DisplayLink has successfully installed, RESTART YOUR LAPTOP
 Once your laptop is restarted, plug in SideTrak to check for compatibility.
 WAIT FOR 2 MINUTES AND 30 SECONDS FOR SIDETRAK TO CONNECT

For any questions or troubleshooting, visit sidetrak.com/pages/download-mac to watch video tutorials

Installation

- 1 Close laptop
- 2 Peel backing off of adhesive (embedded onto SideTrak™)

Note: Metal plates WILL be semi-permanently adhered to your laptop.
If you would not like to adhere metal plates directly onto laptop,
we recommend using a plastic laptop case or skin (not included).

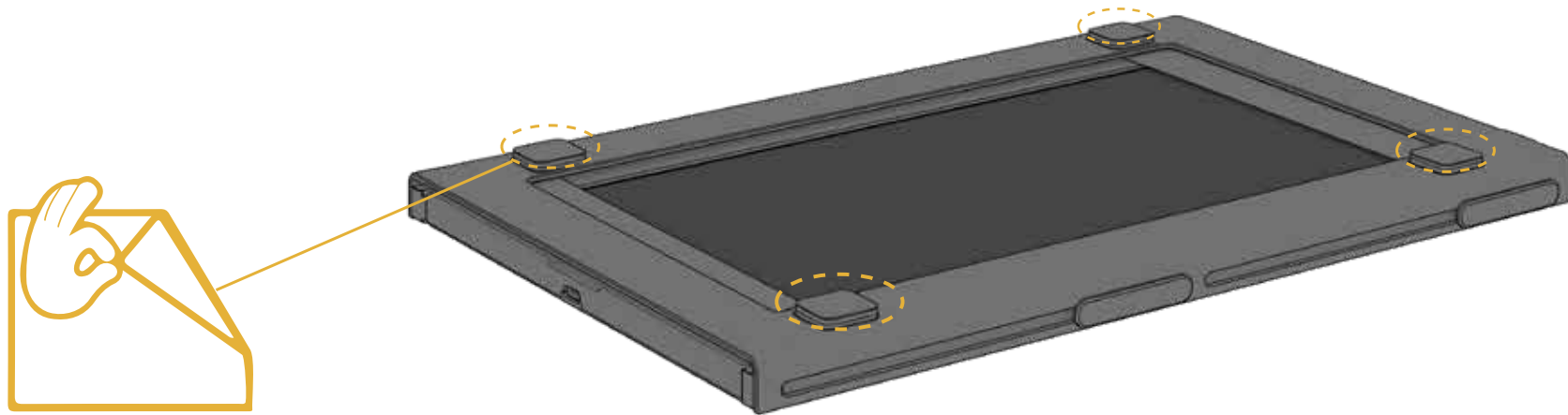

- 3** Apply SideTrak™ (logo side up) onto closed laptop surface.
For best results, apply to laptop center, away from beveled or angled edges.

QUICK TIP

If you would like the SideTrak to slide out to the right, apply with logo side of SideTrak closest to laptop hinge. For SideTrak to slide out to the left, apply upside down.

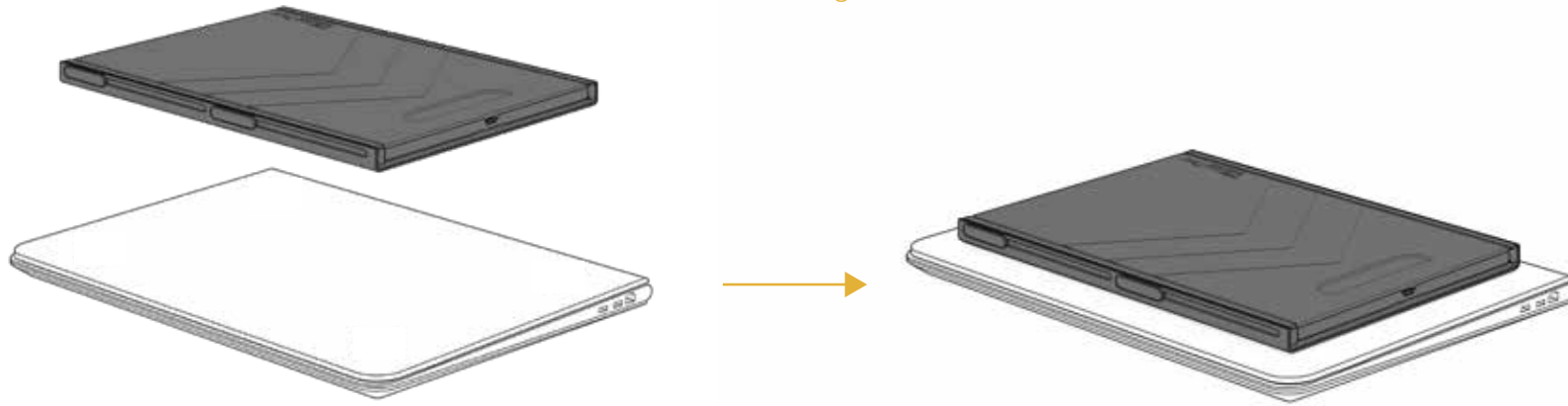

- 4** Apply light pressure to corners of SideTrak for 5–10 seconds before use.

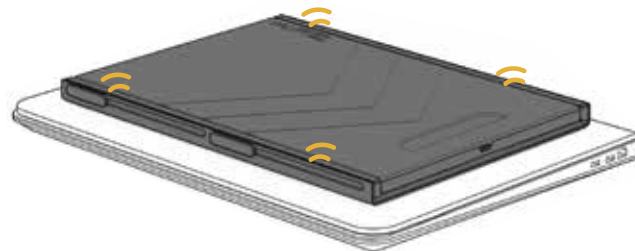

Once you've attached the SideTrak™ to your laptop, you're ready to get working!
 If you experience any issues with installation, turn to Troubleshooting (pg 16)

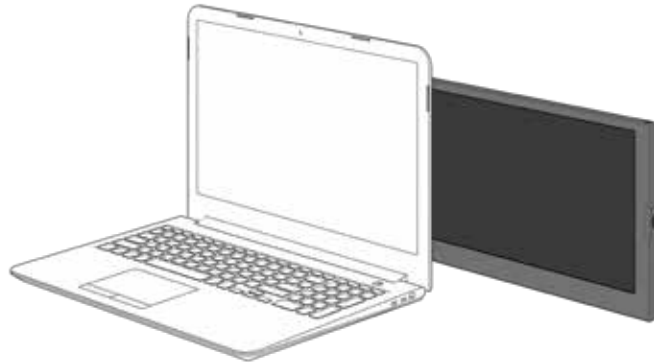

1 Pull SideTrak out

If it seems like the SideTrak is not pulled out all way, if it gets stuck or seems woobly, make sure to slide the screen all the way out until you hear it click on both the top and bottom of the screen.

*Note: Pull screen by holding onto bezel until it “clicks” into its place on the sliding frame. You may also apply light pressure on the top and bottom of the screen on the side attached to the sliding frame until you hear both ends click into place.

2 Plug device back in

The port on either end of the SideTrak will work, plug it in as desired!

Note: Do not run cord through SideTrak rails, as to not break cord or inhibit movement

3 Adjust screen as desired

Change screen angle and distance using SideTrak's patent pending hinged sliding frame

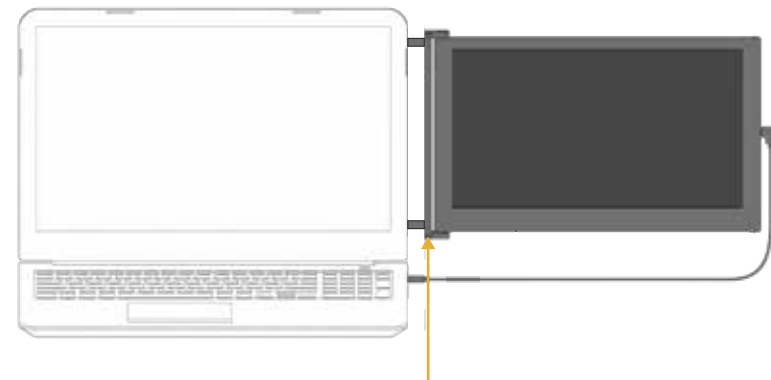

*Note: Before adjusting screen angle, pull SideTrak out so you can see first bar of sliding frame. You will hear the SideTrak click into place when you've pulled it out far enough.

The SideTrak's metal plates will stay on your laptop, making for effortless travel and reuse!

QUICK TIP

Your SideTrak does NOT need to be removed while in transit!
Metal plates ensure that your SideTrak will remain firmly attached to your laptop at all times

To permanently remove metal plates, use the plastic removal tool included with your SideTrak to easily remove adhesive from laptop surface.

To reattach or to use your SideTrak with a different laptop, use the spare set of metal plates included! Load metal plates into mounting frame of SideTrak. Once spare plates attach to mounting frame, peel off backing and attach to SideTrak as normal. (see pg 8)

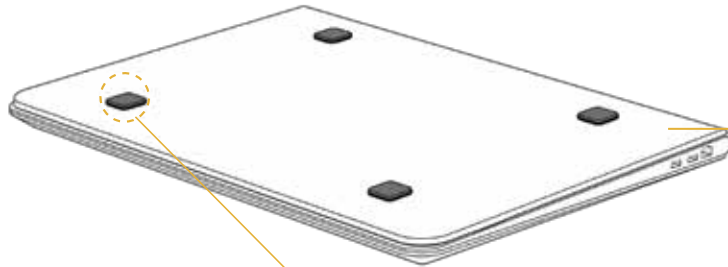

If you would not like to semi-permanently adhere metal plates to your laptop, we recommend using a snap-on laptop case (not included).

Reattaching the SideTrak

Once you have removed the SideTrak from your laptop, reattaching it may take some getting used to!

Angle the SideTrak slightly, “hooking” the mounting frame to the top of the metal plates

You should feel SideTrak **click** onto magnets – For additional help, watch instruction video here: <https://bit.ly/2Tg5MSP>



PC

Configuring a second screen

- Right-click a blank part of laptop home screen
- Select “Screen Resolution” from the drop-down menu that appears
- This will pull up a display settings dialogue box. The SideTrak™ should automatically register as screen 2
- Drag and drop screen icons to match your setup
(i.e. If your SideTrak is installed to slide out to the left of your laptop, arrange your screens to reflect this)
- Select “**Extend these displays**” to use the SideTrak as an extension of your laptop (best for personal use)
- Select “**Duplicate these displays**” to use the SideTrak as a copy of your laptop screen (best for presenting)

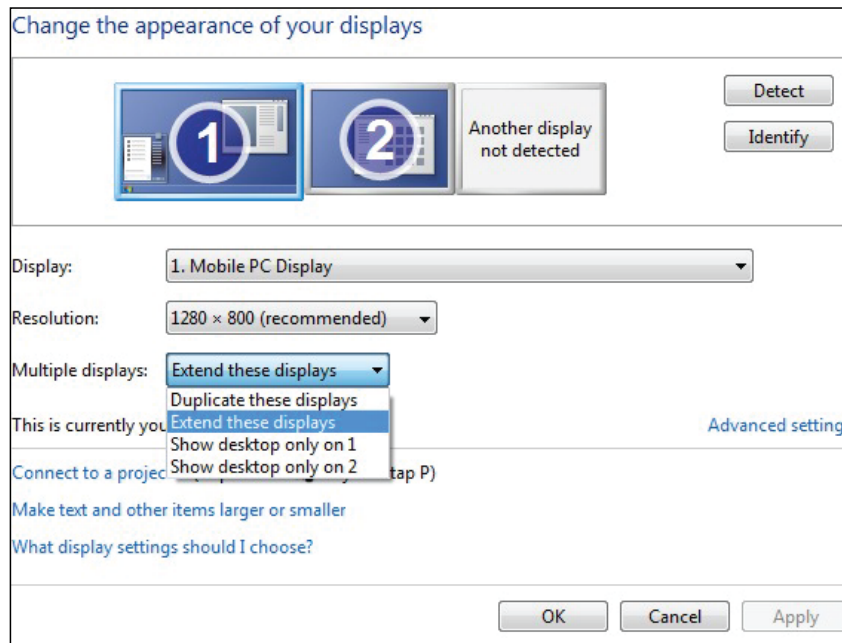

Display settings dialogue box on Windows 7 and older

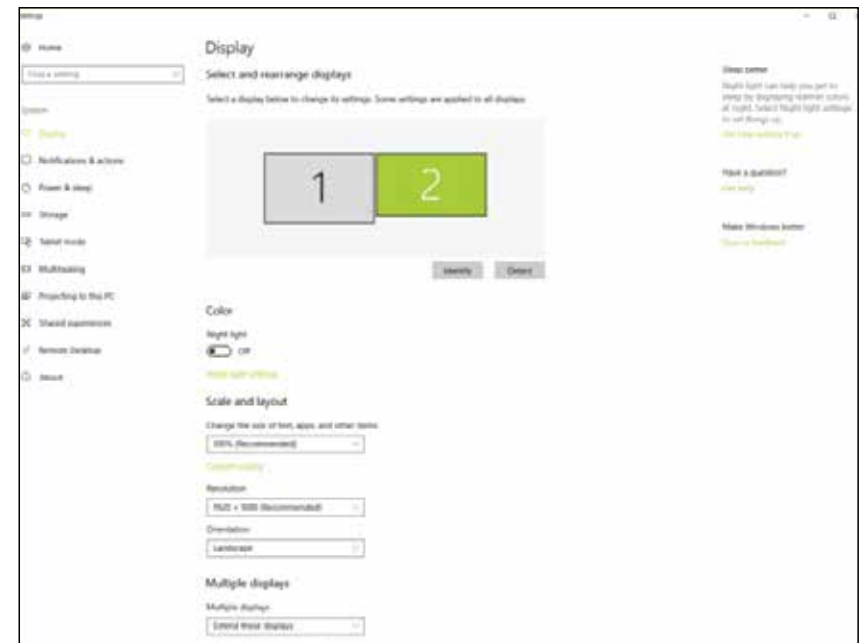

Display settings dialogue box on Windows 10 and newer

Mac

Configuring a second screen

- Select System Preferences icon  from dock
- Select “Displays” from the menu that appears
- This will pull up a display settings dialogue box. The SideTrak™ should automatically register as screen 2
- Select the “Arrangement” tab at the top of the window, then drag and drop screen icons to match your setup (i.e. If your SideTrak is installed to slide out to the left of your laptop, arrange your screens to reflect this)
- The SideTrak will automatically be set up to work as an extension of your laptop (best for personal use)
- Select “**Mirror Displays**” to use the SideTrak as a copy of your laptop screen (best for presenting)

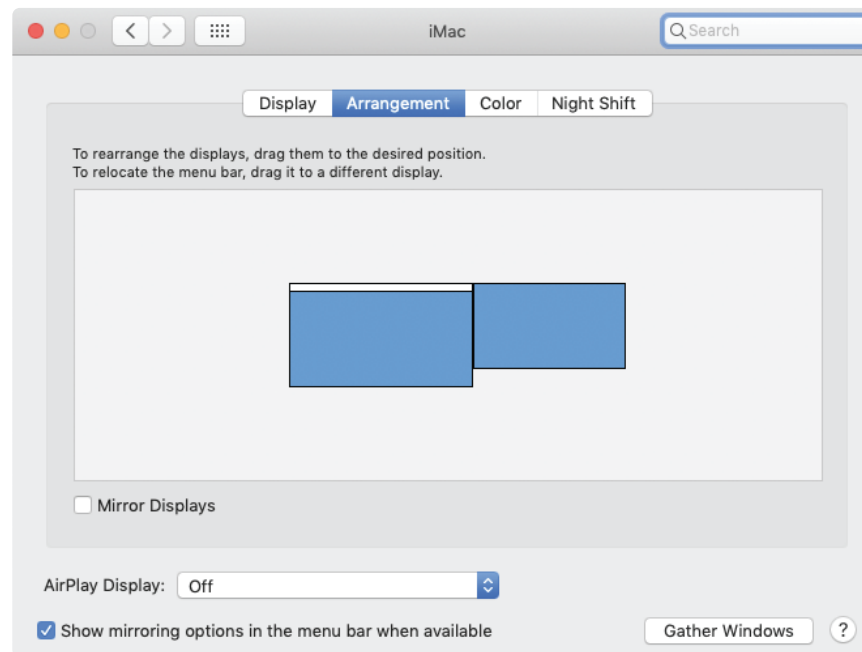

Display settings dialogue box on Mac operating systems

FAQs

- 1** Can the SideTrak™ slide out to the left of my laptop?
Yes! Simply attach onto your laptop with the SideTrak logo facing away from laptop hinge. For an easy way to determine which way your SideTrak will slide, just look at the arrows!

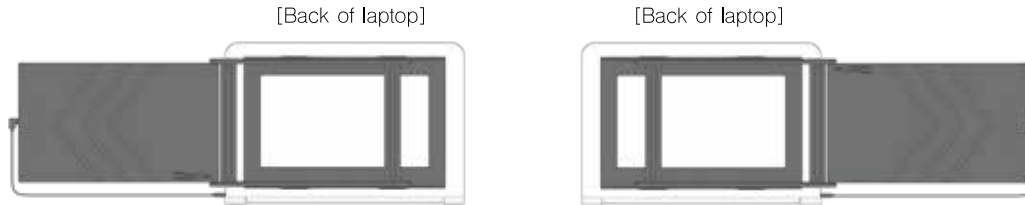

Note: If attaching SideTrak upside down to slide out to the left, you will need to manually flip your screen.
On Macbook: Launch System Preferences, Hold down Command+Option (alt) keys WHILE clicking on "Display" icon. Look for newly visible "Rotation" drop down menu and select 180°
On PC: Right click to select "Display settings" from dialogue box. Select "Landscape (flipped)" from orientation options.
Note: On some PC operating systems you may be able to use shortcut: CTRL+ALT+arrow keys

- 2** Can the SideTrak flip around?
Yes! Just pull the SideTrak out PAST the sliding frame stabilizing bar, then flip all the way back. Once you've flipped the screen around, you can adjust the sliding frame as desired.

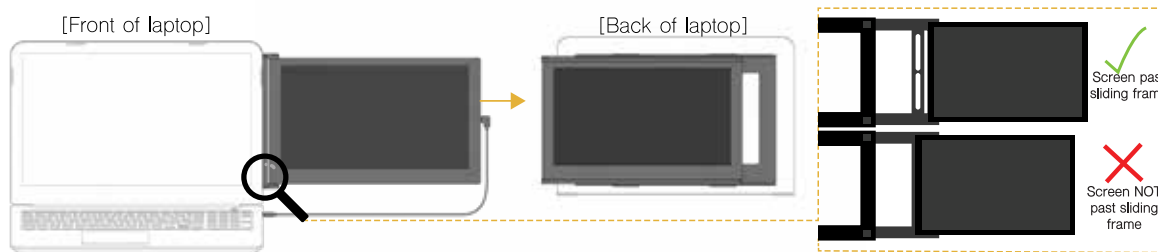

- 3** What if I don't want metal plates on my laptop?
To continue using the SideTrak with your laptop, metal plates will need to remain on laptop's surface. A laptop case, skin, or cover is compatible with the SideTrak, and will also avoid sticking plates directly onto the laptop itself. To permanently remove metal plates, use included removal tool.

- 4** Are the SideTrak's metal plates safe to have near other electronic devices and credit cards?
Yes. The SideTrak uses device-safe magnets that will not interfere with screens or data.

- 5** What if I need a new USB-C cord or set of metal plates?
Replacement parts can be purchased at www.sidetrak.com

- 6** Can the SideTrak work when not attached to a laptop?
Yes, as long as the SideTrak is plugged into a functioning laptop that is on, it will work as a mirror or extension of that laptop. For best practice, we recommend using the SideTrak attached to your laptop as intended.

- 7** What warranty is included with the SideTrak?
The SideTrak includes a 1-year limited liability warranty. See page 13 for details.

- 8** Will the SideTrak work with Mac and PC?
The SideTrak should be compatible with all Mac and PC laptops manufactured within in the past 5 years.

1 SideTrak will not turn on and/or load

Initial Troubleshooting Steps for Windows

1. Make sure your laptop is turned on and open
2. If possible, update your computer to the latest software
3. Update DisplayLink by uninstalling the current version, using the DisplayLink Cleaner (<https://www.displaylink.com/downloads/file?d=64>) and installing the latest version
4. Plug the SideTrak directly into all ports on your computer and wait 2.5 minutes after each port
5. Try the SideTrak on another computer (preferably a computer with a different operating system)
6. Test the SideTrak with a different USB-C or USB-A cord if you have an extra
7. If you are still having trouble with your SideTrak, contact us. We are happy to help you!

Initial Troubleshooting Steps for Mac

1. Make sure your laptop is turned on and open
2. If possible, update your computer to the latest software
3. Update DisplayLink by uninstalling the current version and installing the latest version (<https://sidetrak.com/pages/download-mac>)

Note: If you have Catalina Operating System and haven't been able to get your SideTrak working, try installing the Mac Catalina Beta 2 download (<https://www.displaylink.com/downloads/file?id=1433>)
4. Reset Displaylink by switching between the mirror and extended display mode
5. Plug the SideTrak directly into all ports on your computer and wait 2.5 minutes after each port
6. Try the SideTrak on another computer (preferably a computer with a different operating system)
7. Test the SideTrak with a different USB-C or USB-A cord if you have an extra
8. If you are still having trouble with your SideTrak, contact us. We are happy to help you!

- 2** I accidentally put metal plates in the wrong place
Use included removal tool to remove adhesive from laptop surface then use spare set provided to re-attach metal plates in desired location

- 3** SideTrak won't clip onto metal plates
Line up SideTrak with the top of metal plates, "hooking" the SideTrak's mounting frame to the top of the metal plates. Magnets should then attach, allowing you to firmly attach SideTrak—You should feel SideTrak click onto magnets.



- 4** Screen doesn't slide out all the way
First: Watch our installation video here! <https://bit.ly/2Tg5MSP>
- Pull bezel ONLY, do not grab onto mounting or sliding frame
 - Make sure you're pulling in the CORRECT direction (look at the arrows on your SideTrak to make sure!)

For more troubleshooting issues please visit our troubleshooting page (sidetrak.com/pages/troubleshooting)

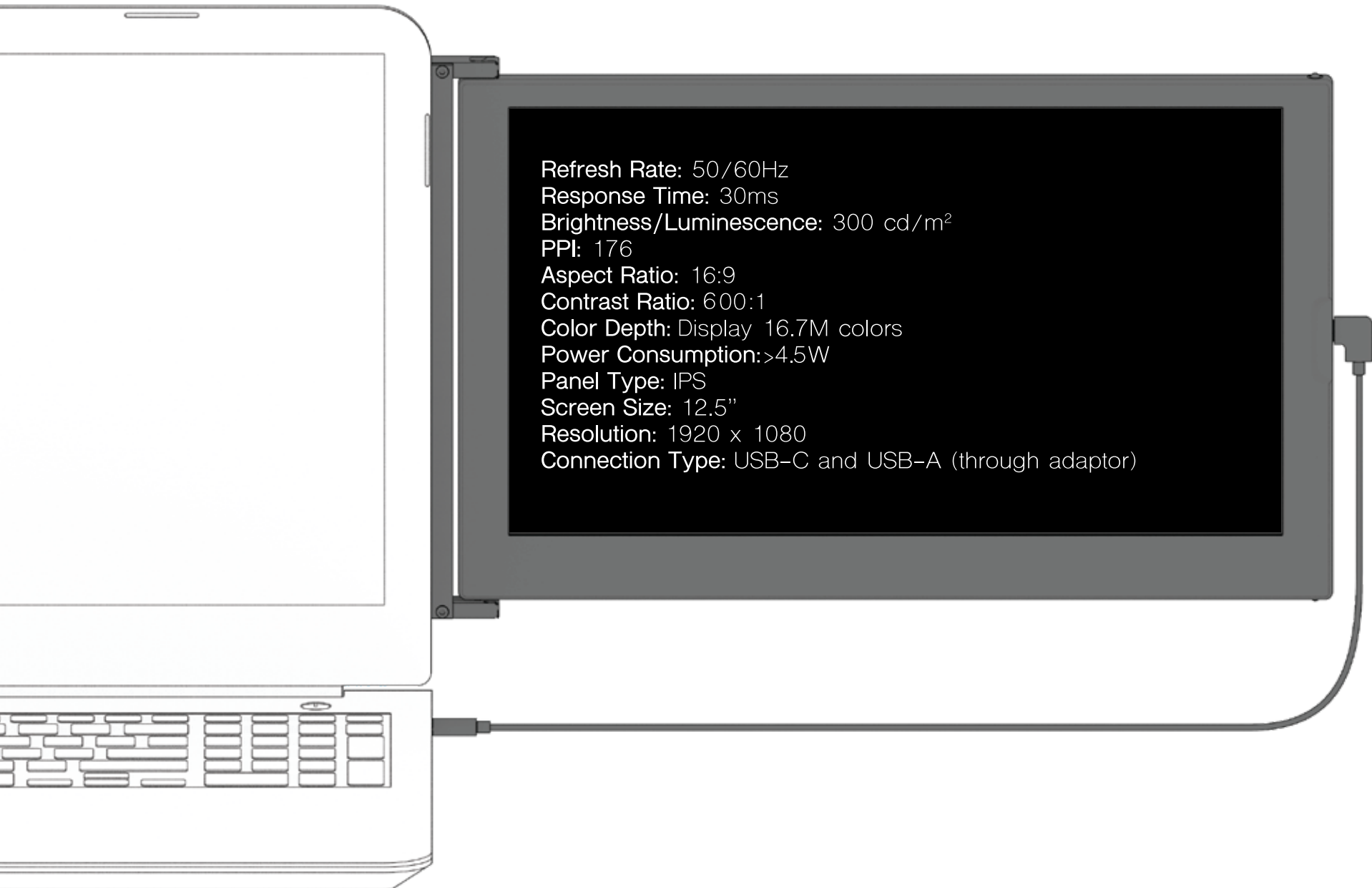



LIMITED LIABILITY WARRANTY

This limited warranty gives you specific legal rights and you may also have other rights, which vary from state to state. The limited warranty can also be found online at sidetrak.standsteady.com/pages/warranty and in the documentation we provide with this product. We warrant that during the warranty period, the product will be free from defects in materials and workmanship. We limit the duration and remedies of all implied warranties, including without limitation the warranties of merchantability and fitness for a particular purpose to the duration of this express limited warranty. Some states do not allow limitations of how long an implied warranty lasts, so the above limitation may not apply to you. Our responsibility for defective goods is limited to replacement or refund as described below in this warranty statement.

WHO MAY USE THIS WARRANTY?

Stand Steady Company, LLC located at address 2700 Prosperity Avenue, Suite 290, Fairfax, VA 22031 ("we") extend this limited warranty only to the consumer who originally purchased the product ("you"). It does not extend to any subsequent owner or other transferee of the product.

WHAT DOES THIS WARRANTY COVER?

This limited warranty covers defects in materials and workmanship of the SideTrak Monitor (the "product") for the Warranty Period as defined below.

WHAT DOES THIS WARRANTY NOT COVER?

This limited warranty does not cover any damage due to: (a) transportation; (b) storage; (c) improper use; (d) failure to follow the product instructions or to perform any preventive maintenance; (e) modifications; (f) unauthorized repair; (g) normal wear and tear; or (h) external causes such as accidents, abuse, or other actions or events beyond our reasonable control.

WHAT IS THE PERIOD OF COVERAGE?

This limited warranty starts on the date of your purchase and lasts for **1 year** (the "Warranty Period"). The Warranty Period is not extended if we replace or repair the product or extend a refund. We may change the availability of this limited warranty at our discretion, but any changes will not be retroactive.

WHAT ARE YOUR REMEDIES UNDER THIS WARRANTY?

With respect to any defective product during the Warranty Period, we will, in our sole discretion, either: (a) replace or repair such product (or the defective part) free of charge or (b) refund the purchase price of such product. We will also pay for shipping and handling fees to return the repaired or replacement product to you if we elect to replace or repair the defective product.

HOW DO YOU OBTAIN WARRANTY SERVICE?

To obtain warranty service, you must call 240-580-8725 or email our Customer Service Department at customerservice@sidetrak.com during the Warranty Period to receive warranty service. No warranty service will be provided without customer contact within the Warranty Period.

LIMITATION OF LIABILITY

The remedies described above are your sole and exclusive remedies and our entire liability for any breach of this limited warranty. Our liability shall under no circumstances exceed the actual amount paid by you for the defective product, nor shall we under any circumstances be liable for any consequential, incidental, special or punitive damages or losses, whether direct or indirect. Some states do not allow the exclusion or limitation of incidental or consequential damages, so the above limitation or exclusion may not apply to you.